

# The E-Class Saloon



Mercedes-Benz

The best or nothing.







## Made to win the day

Master every task. The new E-Class Saloon offers all you need to do so: space, comfort, safety and pioneering innovations. The more dynamic design, carefully considered safety features, a digital cockpit, MBUX and sophisticated comfort features set new benchmarks in the luxury segment.





## Space for a sense of assurance

A sportily elegant rear end and a high level of functionality: the new E-Class Saloon is an absolute eye-catcher with its broad shoulders and high-quality rims.





## High performance

High-quality materials, innovative technology and even greater comfort: the interior of the new E-Class Saloon has everything that makes your daily life better. The centerpiece is the digital cockpit: the high-resolution multimedia display makes the vehicle as intuitive to operate as a smartphone.



## Ahead in safety

As a pioneer in matters of safety, Mercedes-Benz has always played an important role.

And this experience is apparent in the new E-Class Saloon as well. A host of ex-factory assistance and safety systems look out to ensure that you look out.







## Unbeatable comfort

The new E-Class Saloon is practically unbeatable in matters of comfort. Massage seats, air cooling, first-class sound provided by the Burmester® surround sound system or the ambient lighting sometimes make you forget that you are sitting in a car.





## MBUX

An E-Class Saloon that wants to get to know you. Thanks to intelligent MBUX with natural voice control, your vehicle adapts to your needs and knows what is important to you. With the digital high-resolution multimedia displays, which can be customised, you navigate everyday life with aplomb.



## Burmester® surround sound system (Optional Equipment)

The unique sound systems from Burmester® provide first-class surround sound in the new E-Class Saloon. This sound can even be optimised by seating area for the front or rear seats. As a result, you enjoy an even more intensive listening experience.



## LED high performance headlamp

The LED High Performance headlamps provide more safety at night and an unmistakable, distinctive look.

LED technology illuminates the road ahead better than conventional headlamp – and it use less energy.



## Panoramic sliding sunroof

Experience a wonderful feeling of freedom and enjoy a pleasantly bright ambience in the interior





## Ambient lighting

Showcase the interior according to your personal preferences or current mood.

The 64 colours of the ambient lighting create exciting colour schemes, which can alternate dynamically or illuminate several areas in different colours.



## Touchpad without controller

You can operate the display of the infotainment system as you would a smartphone and move or enlarge the content quite simply with single gestures .

The touchpad recognises your handwriting should you wish to enter addresses or phone numbers.



## Smartphone integration

Smartphone integration links the mobile phone with the media system via Apple CarPlay or Android Auto. This gives you convenient access to the most important apps on your smartphone.



## Multifunction steering wheel

Combines fine materials with innovative ease of operation. Via the Touch Control panels you operate the key vehicle functions without having to take your hands off the steering wheel.

Photos for reference only (only applies to E 200 Exclusive Facelift and E 200 AMG Line Facelift)





## Widescreen cockpit

All key driver information is displayed on a screen diagonal of 12.3 inch with 3 selectable display styles, namely "Classic", "Sport" and "Progressive".

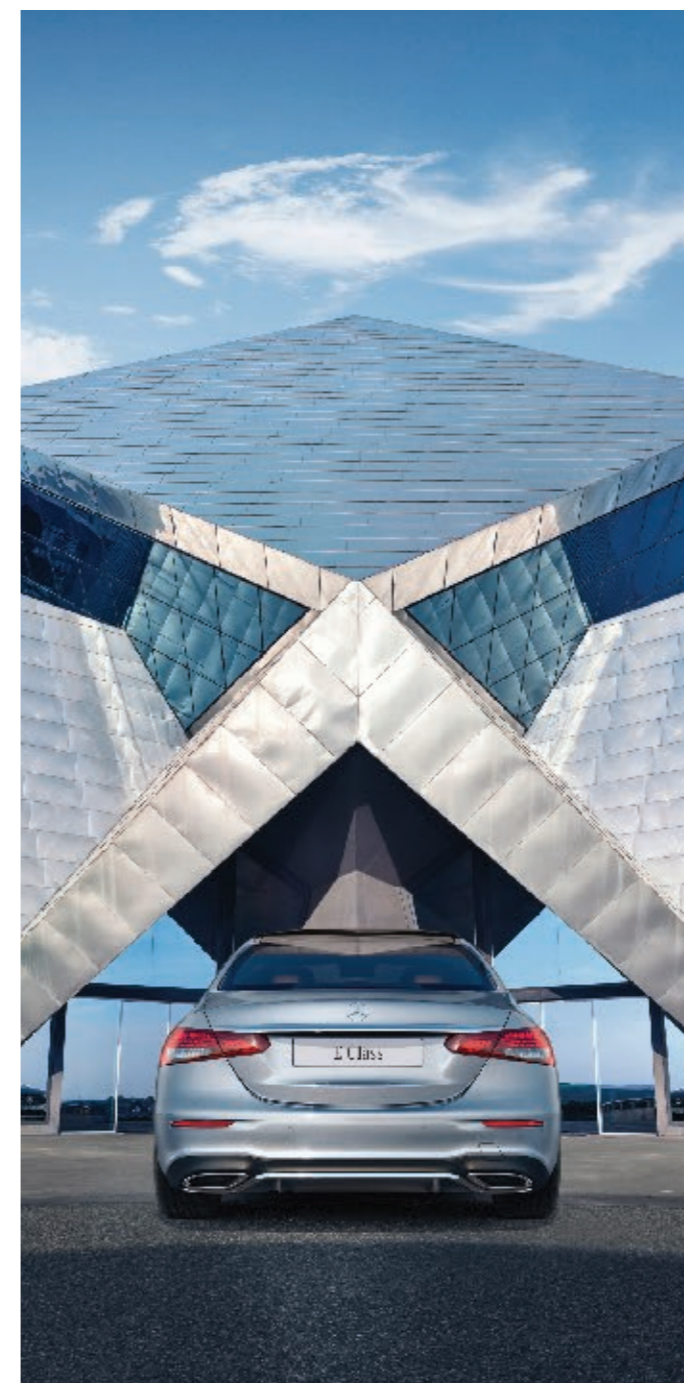

## 360° camera

Active Parking Assist with 360° camera makes it easier for you to find a parking space and to manoeuvre into and out of parking spaces. The choice is yours: thanks to all-round visibility, you can park your vehicle yourself – or let your vehicle do the parking without stress.





## EXCLUSIVE

Demonstrate that you care strongly about elegance and prestige: with the EXCLUSIVE exterior, your focus is on classic Mercedes-Benz design and on stylish chrome touches.

The interplay of all elements conveys a classy overall impression.



## AMG Line

Demonstrate that you care strongly about sportiness: with the discrete styling of the AMG Line, your focus is on modern design and striking dynamics. The interplay of all elements conveys an expressive overall impression. The lowered suspension clearly underscores this effect – and offers lots of driving fun to boot.







# Paintwork

## Non-metallic paints

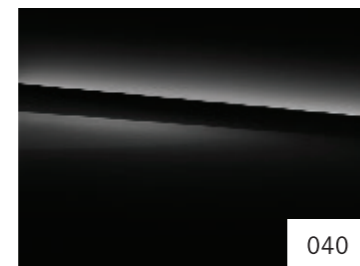

040

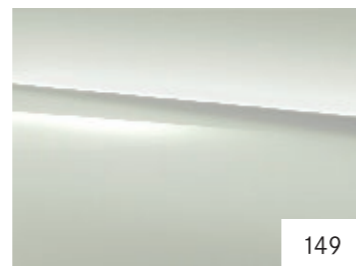

149

## Metallic paints

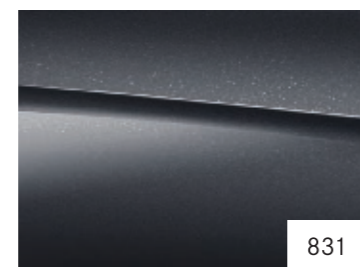

831

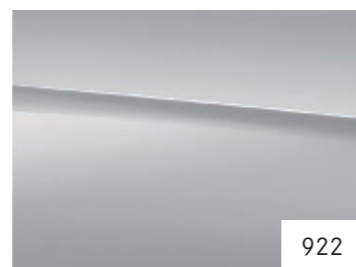

922

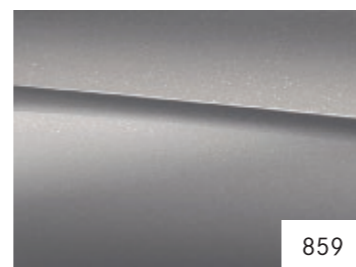

859

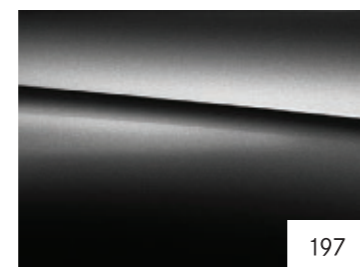

197

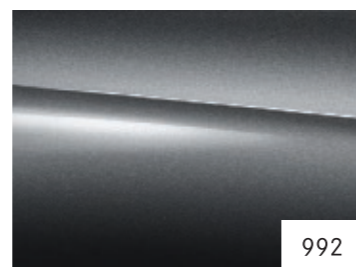

992

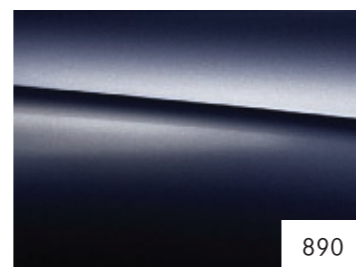

890

## Designo paints



799

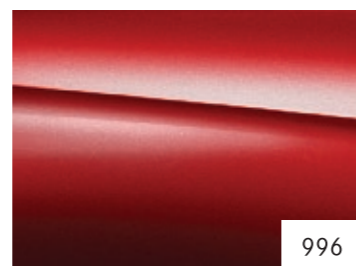

996

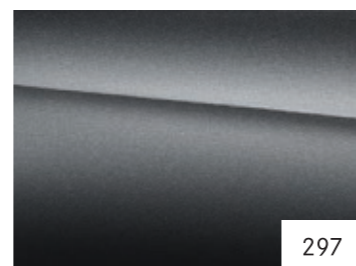

297

### Non-metallic paints

040 Black

149 Polar white

### Metallic paints

831 Graphite grey

922 High-tech silver

859 Mojave silver

197 Obsidian black

992 Selenite grey

890 Cavansite blue

### Designo paints (optional)

799 Designo diamond white bright | HK\$ 10,600 (pre-tax)

996 Designo hyacinth red metallic | HK\$4,600 (pre-tax)

297 Designo selenite grey magno | HK\$27,000 (pre-tax)

Colors for reference only.

# Wheels

## EXCLUSIVE



61R

## AMG Line



RSJ

## Optional



R97

## Optional



RZI



RVR



RVQ



RRD

## EXCLUSIVE

61R 18" 10-twin-spoke light-alloy wheels

R97 19" 10-spoke light-alloy wheels (Not in conj with P55)  
HK\$ 15,500 (Optional)

## AMG Line

RSJ 18" AMG 5-twin-spoke light-alloy wheels

RZI 19" AMG 5-twin-spoke light alloy wheels | HK\$4,500  
(Optional)

RVR 20" AMG multi-spoke alloy wheels (Only in conj with  
P55 at extra charge) | HK\$ 15,500 (Optional)

RVQ 20" AMG multi-spoke alloy wheels (R66 is included at  
\$0) | HK\$ 15,500 (Optional)

RRD 19" AMG 10-spoke light-alloy wheels (Not in conj with  
P55) | HK\$7,100 (Optional)

Photos for reference only.



# Upholstery



121  
ARTICO man-made leather  
Black

124  
ARTICO man-made leather  
Hazelnut brown/black

125  
ARTICO man-made leather  
Macchiato beige/black

128  
ARTICO man-made leather  
Alpaca grey

Photos for reference only.

# Trim

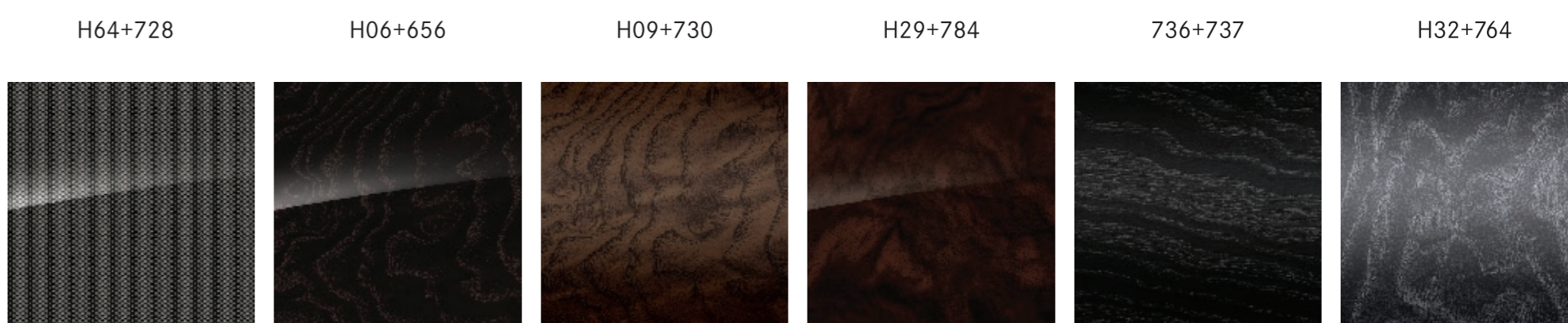

H64+728

H06+656

H09+730

H29+784

736+737

H32+764

Metal-weave trim

Brown high-gloss  
ash wood trim

Brown open-pore  
ash wood trim

High-gloss brown burr  
walnut wood trim

Open-pore black  
ash wood trim

Grey open-pore  
ash wood trim

Centre console in  
black pianolacquer look

Centre console in  
high-gloss brown  
ash wood

Centre console in  
light brown open pore  
ash wood

Centre console in  
high-gloss burr  
walnut wood

Centre console in  
black open-pored  
ash wood

Centre console in  
grey open-pore ash wood

Colors for reference only.



# Technical data

	Petrol engines	
	E200	E300
Displacement (cc)	1,991	1,991
Rated output <sup>1</sup> (kW [hp] at rpm)	145 (197)/5,500-6,100	190 (258)/5,500-6,100
Acceleration from 0 to 100 km/h (s)	7.5	6.2
Top speed (km/h)	240	250
Fuel consumption <sup>2</sup> (l/100 km)		
Urban	9.4-8.9	9.4-8.9
Combined	7.1-6.6	7.1-6.6
Combined CO <sub>2</sub> emissions <sup>2</sup> (g/km)	162.0-151.0	162.0-151.0

# Dimensions

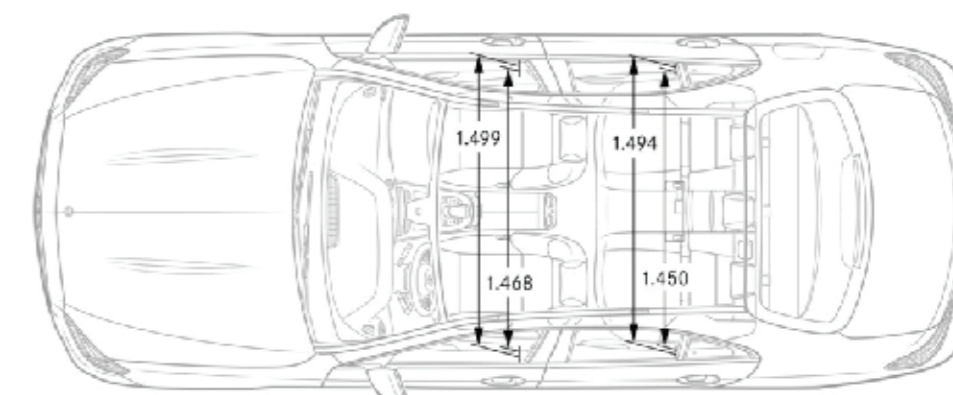
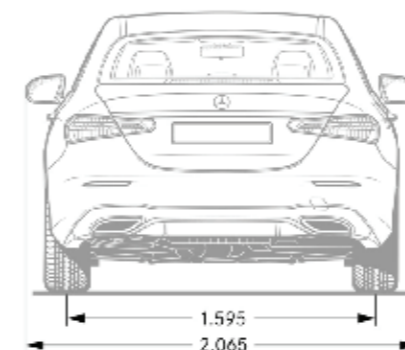
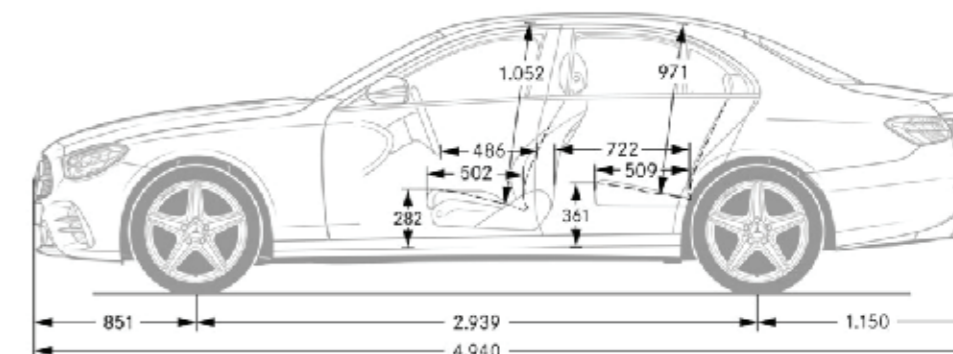
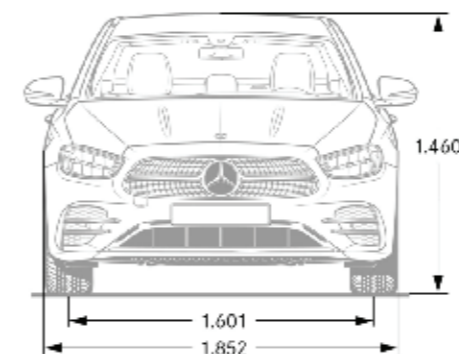

<sup>1</sup> Rated output and torque figures in accordance with Directive 80/1269/EEC in the currently applicable version.  
<sup>2</sup> The figures shown were obtained in accordance with the prescribed measuring process. They are "NEDC CO<sub>2</sub> values" pursuant to Art. 2 No. 1 of Implementing Regulation (EU) 2017/1153. The fuel consumption figures have been calculated on the basis of these values. Electrical consumption has been determined on the basis of Directive 692/2008/EC.

All figures in millimetres. The pictured dimensions are mean values. They are valid for vehicles in basic specification and in unladen condition.





Zung Fu 仁孚